



# Laparoscope

*Instructions for Use*





# Laparoscope

*Instructions for Use*





### Corporate Headquarters

Quest Medical Imaging B.V  
Industrieweg 41  
1775 PW Middenmeer  
The Netherlands

Website: [www.quest-mi.com](http://www.quest-mi.com)

### Customer Service and Technical Support

Email: [info@quest-mi.com](mailto:info@quest-mi.com)  
Phone: +31-227-60-40-46  
Fax: +31-227-60-41-85

### Contact USA

Quest Medical Imaging Inc.  
10000 Cedar Avenue  
Suite 3-164  
Cleveland, OH 44106 U.S.A.

### Customer Service and Technical Support

Email: [info@quest-mi.com](mailto:info@quest-mi.com)  
Phone: +1-33-07-52-65-96  
Fax: +1-33-07-52-65-97

### Document Identification

Document: QMI0024\_IFU\_EN\_06012022\_v2  
Revision: 2  
Date of revision 06/01/2022

**Copyright statement:**

**© 2021 Quest Medical Imaging B.V.**

**All rights reserved. No part of this document may be photocopied, reproduced, or translated in any way, without the prior written consent of Quest Medical Imaging B.V.**

**Every effort has been made to make the supplied product and its documentation as accurate as possible.**

**The information contained in this document is subject to change without notice.**

**Printed in The Netherlands.**

## Table of Contents

<b>1</b>	<b>Health and Safety Compliance</b> .....	<b>3</b>
1.1	Important Information .....	3
1.2	Indication for Use.....	3
1.3	Foreseeable misuse .....	3
1.3.1	Contraindications:.....	3
1.4	User Qualifications.....	4
1.5	Repair and Modification.....	4
1.6	Labels on Packaging .....	5
<b>2</b>	<b>Safe application and preparation</b> .....	<b>6</b>
2.1	Packaging and storage.....	6
2.2	Prior Use.....	6
2.3	Intraoperative Use .....	6
<b>3</b>	<b>Assembly and Disassembly</b> .....	<b>8</b>
3.1	Combinations.....	9
<b>4</b>	<b>Cleaning/Disinfection</b> .....	<b>10</b>
4.1	Safe treatment .....	10
4.2	After every use.....	10
4.3	Manual cleaning/disinfection .....	11
4.4	Machine cleaning/disinfection.....	11
4.5	Maintenance, checking.....	12
4.6	Packing .....	12
<b>5</b>	<b>Sterilization</b> .....	<b>13</b>
5.1	General Remarks.....	13
5.2	Sterilization method .....	13
5.3	Storage .....	13
5.4	Information on validation .....	14
<b>6</b>	<b>Accessories/spare parts</b> .....	<b>15</b>
<b>7</b>	<b>Standards/Directives</b> .....	<b>16</b>
<b>8</b>	<b>Disposal</b> .....	<b>17</b>
8.1	General Remarks.....	17
8.1.1	Wet Disposal.....	17
8.1.2	Dry Disposal .....	17
<b>9</b>	<b>Product Life cycle</b> .....	<b>18</b>
<b>10</b>	<b>Technical Specifications</b> .....	<b>19</b>
<b>11</b>	<b>Manufacturer declaration</b> .....	<b>20</b>

# 1 Health and Safety Compliance

## 1.1 Important Information

 **WARNING:**      **Read Before Use**



This instruction manual contains essential information on using the Quest Spectrum® Laparoscopes safely and effectively. Before use, thoroughly review this manual and use the system as instructed.

Keep this manual in a safe, accessible location. Questions or comments about any information in this manual should be sent to Quest Medical Imaging B.V.

The following signal words serve to distinguish between warning notes according to the type of danger:



**WARNING:**      indicates risks to the safety of the patient or user. Failure to follow warnings may result in injury to the patient or user.



**CAUTION:**      indicates risks to the equipment. Failure to follow cautions may result in product damage.



**Note:**      provides special information to clarify instructions or present additional useful information.

## 1.2 Indication for Use

During the examination, diagnosis and/or (in combination with endoscopic accessories) treatment, Laparoscopes serve exclusively to visualize the abdominal cavity.



**WARNING:**      **The Quest Spectrum® Laparoscope should be used according to its approved Indication for Use.**

## 1.3 Foreseeable misuse



**WARNING:**      **Do not use Laparoscopes for other endoscopic applications.**



**WARNING:**      **Connect Laparoscopes exclusively to BF devices (body floated devices).**



**WARNING:**      **Do not use Laparoscope in combination with the Quest Spectrum® 3 Mechanical Arm**

### 1.3.1 Contraindications:

- ❖ General inoperability
- ❖ Ambiguous diagnosis
- ❖ Lack of willingness on the part of the patient
- ❖ Technical preconditions not met

## 1.4 User Qualifications

This manual is addressed exclusively to qualified personnel (licensed physician, medical assistants supervised by a licensed physician). The Quest Spectrum® Laparoscope is to be used exclusively by qualified personnel to carry out clinical applications.



**WARNING:** This manual does not explain or discuss clinical procedures. The qualified personnel is responsible for correct execution of clinical procedures.

## 1.5 Repair and Modification



**WARNING:** Do not disassemble, modify, or attempt to repair the Quest Spectrum® Laparoscopes. Patient or user injury and/or instrument damage can result

- ❖ Let exclusively the respective dealer or a repair facility authorized by Quest Medical Imaging B.V carry out repair works.
- ❖ Use exclusively original spare parts for repair works.

Before sending it back:

- ❖ Clean, disinfect and sterilize the light guide cable and laparoscope thoroughly prior to returning for repair.
- ❖ Return the part in its original packaging. If this is not possible, package the part to secure it for transport.
- ❖ Quest Medical Imaging is not liable for damage resulting from improper shipping.













**Note:**

The guarantee and warranty claims expire if repair works are not carried out by repair facilities authorized by Quest Medical Imaging B.V.

## 1.6 Labels on Packaging

Table 1: Labels on Packaging

Observe Operating Instructions	
Date of Manufacture	
Manufacturer	
Change designation	
Serial number	
Article number	
Working Length	
Non-sterile	
Keep away from sunlight	
Keep dry	

## 2 Safe application and preparation

### 2.1 Packaging and storage



**WARNING:** The laparoscope is not sterile packed.

- ❖ Prior to the first sterilization, clean the laparoscope thoroughly (manually or using a machine according to chapter 4).
- ❖ After every use, clean, disinfect and sterilize the laparoscope (see chapter 4 Cleaning/ Disinfection).
- ❖ Keep the new or unused laparoscope in a dry, clean and safe place at room temperature.
- ❖ Store and pack laparoscopes individually in a dry place at room temperature.



**CAUTION:** Do not bend the laparoscope.



**Note:** To prevent damages on the working end: Insert the laparoscope carefully through a trocar.

### 2.2 Prior Use



**Note:** After every cleaning/disinfection and prior to every use, check the laparoscope for: cleanness, function and damages, e.g. insulation, loose, bent, broken, chapped, rough, worn, broken off parts etc.



**WARNING:** Do not use a damaged or defective laparoscope. Contact Quest Medical Imaging B.V.

### 2.3 Intraoperative Use



**WARNING:** It is possible that light with a high radiation energy emerges from the viewing window and raises the temperature of the tissue.

- ❖ Make sure that the surface temperature of the body does not exceed 41 °C.
- ❖ During longer applications, let the body cool down if necessary.
- ❖ Only use light sources from Quest Medical Imaging B.V.



**WARNING:** In case of suspected or diagnosed Creutzfeldt-Jacob syndrome, Quest Medical Imaging B.V. recommends not to reuse the laparoscope but to dispose of it.

Immediately take measures to prevent the infection of other patients, users or third parties.

Observe country-specific laws and specifications.





**CAUTION:**

To maintain the optical quality, make sure that the laparoscopes are not exposed to gamma rays.



**Note:**

Check image quality (clear and free of distortion) and light transmission through the glass fibers.

- ❖ Hold the light guide connector against non-glare light. Should the glass fibers appear as black spots on the distal end (broken glass fibers), it is possible that the light output is insufficient.

### 3 Assembly and Disassembly

Figure 1 shows the construction of the Quest Spectrum® Laparoscope. The Eyepiece can be only connected to the Quest Spectrum® Camera. Table 2 provides an overview of all laparoscopes provided by Quest Medical Imaging B.V and Table 3 provides an overview of all accessories.

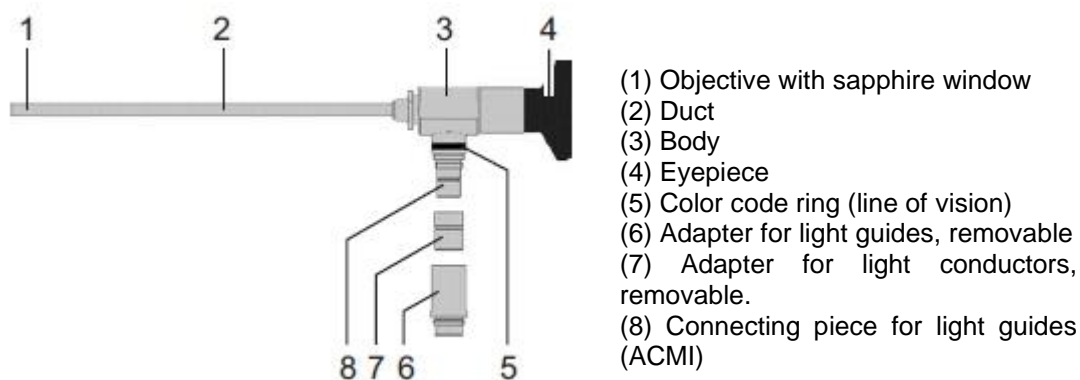

Figure 1: Construction of the Laparoscope



**Note:** Only the light guide connector can be dissembled from the Laparoscope.

Table 2: overview of all laparoscopes provided by Quest Medical Imaging B.V.

Article Number	Line of vision	Color Code	Field of View	Working Length
ART-LAP-0008	30°	Red	70°	290 mm
ART-LAP-0008S	30°	Red	70°	150 mm
ART-LAP-0009	0°	Green	70°	290 mm
ART-LAP-0009S	0°	Green	70°	150 mm

Table 3: accessories of the Laparoscope

Article Number	Name	Use
ART-OP-0007	Optical fiber	Light Guide from Light Engine to Laparoscope

For a safe assembly:

- ❖ Always hold the laparoscope on the body or the eyepiece.
- ❖ Make sure that the adapters of the light- conducting cables comply with the adapters of the laparoscope (see Figure 1).
- ❖ Make sure that glass surfaces do not interact with other instruments.



Figure 2: Connecting the laparoscope to the camera

When assembling, make sure that the three pins on the ring laparoscope fit into the camera (Figure 2).

### 3.1 Combinations



**WARNING:** Danger to life due to high tensions and currents!

Make sure that the leakage currents of the patient are minimized for combinations:

- ❖ Connect the Laparoscopes only to devices and accessories of Quest Medical Imaging B.V.
- ❖ Connect Laparoscopes exclusively to BF devices (body floated devices).



**WARNING:** Do not use Laparoscope in combination with the Quest Spectrum® 3 Mechanical Arm



**Note:**

Contact Quest Medical Imaging B.V if you want to connect devices not provided by Quest Medical Imaging B.V.

## 4 Cleaning/Disinfection

### 4.1 Safe treatment

Make sure that laparoscopes and accessories are cleaned and sterilized exclusively by trained and qualified personnel.

- ❖ Clean and sterilize laparoscopes before first use. Remove protective transport sheaths.
- ❖ Exclusively treat laparoscopes and accessories suitable for:
  - immersion in cleaning agent
  - vapor sterilization
- ❖ Use exclusively cleaning agents for complete protein dissolution.



**WARNING:** Do not exceed maximum number of treatments (see manual of respective product).



**WARNING:** Do not use laparoscopes or accessories once their product lives are expired (see manual of respective product).



**WARNING:** Treat laparoscopes and accessories before the first and after every use.



**WARNING:** Make sure that laparoscopes and accessories do not touch during cleaning.



**WARNING:** Prevent any fixation of proteins before and during treatment.



**CAUTION:** Do not apply strong manual pressure.



**CAUTION:** Do not use abrasive cleaning agents or metal brushes.



**CAUTION:** Do not use plastic sheaths for treatment.



**CAUTION:** Do not clean laparoscopes in an ultrasonic bath.



**CAUTION:** Do not gamma-sterilize laparoscopes.

### 4.2 After every use

After every use treat contaminated laparoscopes and accessories as soon as possible.

1. Disassemble detachable laparoscopes and accessories.
2. Remove sealing caps.
3. Soak encrusted laparoscopes and accessories in 3 % H<sub>2</sub>O<sub>2</sub> for 5 minutes before cleaning and disinfection.
4. Use fully desalinated water. Clean manually or in a machine. Observe manufacturer's indications (e.g. dosing).
5. Always machine-clean after contact with:
  - ❖ blood
  - ❖ wounds
  - ❖ interior tissue
  - ❖ organs



**CAUTION:** In case of contact with a corrosive substance, clean with water immediately.

### 4.3 Manual cleaning/disinfection



**Note:** Clean laparoscopes and accessories manually exclusively when machine cleaning is not possible.

To clean the laparoscopes and accessories manually, perform the following steps:

1. Observe indications of cleaning agent manufacturer.
2. Use a cleaning agent with a medium pH value (5 - 11).
3. If immediate cleaning is not possible: Soak laparoscopes and accessories in enzymatic cleaning agent for 15 minutes in such a way that all surfaces, cavities, lumens, and openings are covered. Observe indications of disinfectant manufacturer.
4. Do not exceed maximum soaking time of 15 minutes.
5. Clean windows (distal and proximal) and glass fiber ends with a cotton swab (wood) or soft cloth soaked in isopropyl alcohol (70%) or acetone. Alternatively, use a neutral detergent (hand soap).
6. After chemical disinfection, always rinse sufficiently and thoroughly under clear running water. Observe indications of disinfectant manufacturer.
7. Remove stubborn dirt with a soft plastic brush. Do not use abrasive cleaning agents or metal brushes.
8. Clean lumens and channels using soft round plastic brushes, and rinse thoroughly.
9. Use fully desalinated water for final rinsing.
10. Dry laparoscopes with an absorbent, soft, and lint-free cloth.
11. Dry laparoscopes at 60 °C for at least 2 hours.
12. Use compressed air to dry lumens and channels.
13. After cleaning. Lubricate cocks using an approved lubricant.



**Note:** Diameters of lumens and brushes must be the same.

### 4.4 Machine cleaning/disinfection



**Note:** Quest Medical Imaging B.V recommends machine cleaning for laparoscopes and accessories.

To clean the laparoscopes and accessories with a machine, perform the following steps:

1. Carry out thermal disinfection in a machine. Observe national requirements regarding A0 value (see ISO 15883).
2. Clean laparoscopes and accessories exclusively in instrument washers, and with suitable methods.
3. Observe indications of ultrasound cleaner, washers and cleaning agent manufacturers.
4. Make sure that manufactures of ultrasound cleaners, washers, and cleaning agents recommend their methods for laparoscopes and accessories.
5. For machine cleaning, put laparoscopes and accessories on suitable screen baskets suitable for cleaning (avoid "cleaning shadows").
6. Make sure that laparoscopes and accessories are properly secured in the holders.
7. Connect rinsing or working channels of laparoscopes and accessories to rinsing connectors of washer.
8. Use a cleaning agent with a medium pH value (5 - 11).
9. Soak laparoscopes and accessories in enzymatic cleaning agent for 15 minutes at most.
10. Use thermically neutral methods in the pH-neutral range (e.g. enzymatic cleaning agents).

11. Select cleaning cycle depending on material (e.g. stainless instrument steel, aluminum) of laparoscopes and accessories to be cleaned. Observe indications of device manufacturer.
12. Pre-rinse laparoscopes twice.
13. Clean laparoscopes at 40 °C - 60 °C.
14. Disinfect at 80 °C - 95 °C.
15. Dry at 50 °C.
16. Observe sufficient drying time.
17. Make sure that there is no residue on the glass fiber surface. This can possible impair light transmission through burning in when exposed to a light source.
18. Take laparoscopes and accessories out of washer immediately when cleaning cycle is finished.
19. Allow laparoscopes and accessories to cool down to room temperature ( $23 \pm 2$  °C).

#### 4.5 Maintenance, checking

- ❖ Allow laparoscopes and accessories to cool down to room temperature.
- ❖ After every cleaning and disinfection, check laparoscopes and accessories for protein residue and dirt. Clean contaminated or dirty laparoscopes and accessories again.
- ❖ Lightly grease movable parts (e.g. hinges and ends) with serializable, vapor-permeable protective oil.
- ❖ Use exclusively bio-compatible, paraffin oil based lubricants (exception: latex and rubber).
- ❖ Assemble detachable laparoscopes and accessories.
- ❖ After every cleaning/disinfection, check laparoscopes and accessories for: cleanliness, proper functioning, and damage, e.g. loose, bent broken, cracked, worn, missing parts etc.
- ❖ Reject and replace damaged, defective, stained, or cloudy laparoscopes and accessories.
- ❖ Laparoscopes and accessories are maintenance-free.

#### 4.6 Packing

- ❖ Always store and package laparoscopes individually.
- ❖ Store laparoscopes in original packaging, or in a suitably sized sterilization container.
- ❖ Store laparoscopes with small diameters (3.0 mm and less) in the protective transport and storage sheaths available at Quest Medical Imaging B.V.

## 5 Sterilization

### 5.1 General Remarks



**Note:**

It is possible for sterilization methods not listed in this manual to be compatible with Quest Medical Imaging B.V laparoscopes and accessories.

When using methods other than those listed in this manual, the user is responsible for the sterility.

- ❖ Use exclusively suitable methods for sterilizing laparoscopes and accessories (see chapter 5.2 Sterilization method).
- ❖ Make sure that a sufficient number of sterile laparoscopes and accessories is available.

Observe the following when sterilizing:

1. Clean laparoscopes thoroughly before sterilizing (see chapter 4 Cleaning/disinfection).
2. Make sure that the entire surface is exposed to the sterilization medium.
3. Avoid any contact with metal surfaces.
4. Make sure that laparoscopes are properly secured in the holders.
5. Do not sterilize laparoscopes still in their protective transport sheaths.
6. Sterilize laparoscopes individually and suitably packaged.

### 5.2 Sterilization method

- ❖ Sterilize laparoscopes and accessories according to generally accepted hospital method.
- ❖ Observe manufacturer's indications for auxiliaries.
- ❖ Make sure that products are packaged according to ISO 11607 and EN 868 for sterilization.
- ❖ Carry out sterilization according to EN 13060/EN ISO 17665-1.
- ❖ Observe applicable country-specific requirements.

Table 4 Validated Sterilization method.

Parameters	134 °C / 273°F Double fore-vacuum	132 °C / 270°F Double fore-vacuum
Sterilization time	3 – 20 min	4 – 20 min
Packaging	Metal sterilization containers, paper laminate sterilization bags, Type Steriking	Metal sterilization containers, paper laminate sterilization bags, Type Steriking



**Note:**

Exclusively vapor-sterilize laparoscopes marked autoclavable.



**CAUTION:**

Do not accelerate cooling of laparoscopes and accessories. This will cause damage and reduce the product life.

- ❖ Allow laparoscopes and accessories to cool down to room temperature (23 ± 2 °C).
- ❖ Open packages after cooling.

### 5.3 Storage

After sterilizing, store laparoscopes in a dry, dust-free, and well-aired place (free of corrosive vapors).

## 5.4 Information on validation

As prescribed by § 4 MPBetreibV, the treatment using a suitable validated method is approved by a laboratory accredited by the ZLG (Central Authority of the Länder for Health Protection with regard to Medicinal Products and Medical Devices in accordance with the directives 93/42/ EWG, 90/385/EWG, and DIN EN ISO/IEC.

The following materials and machines were used for the validation:

- ❖ Disinfectant: Korsolex®
- ❖ Cleaning agent: Neodisher Mediclean by Dr. Weigert
- ❖ Neutralizing agent: Neodisher Z by Dr. Weigert
- ❖ Cleaner: Miele G7735
- ❖ Sterilizing agent: humid heat



## 6 Accessories/spare parts

Our catalogs contain information about accessories and spare parts.

## 7 Standards/Directives

All laparoscopes are manufactured in accordance with the following directives:

- Medical device directive 93/42 EWG last changed by 2007/47/EG
- EN ISO 13485
- Series of standards IEC 60601
- Series of standards ISO 8600
- FDA regulations (FDA Quality System Regulation 21 CFR Part 820) other product and material-specific standards and regulations

## 8 Disposal

### 8.1 General Remarks

For the disposal, mind the following:

- ❖ Dispose of the packaging and used parts in accordance with the country-specific regulations.
- ❖ Protect the device from access by unauthorized persons.

#### 8.1.1 Wet Disposal

- ❖ Use cleaning-active disinfectants.
- ❖ Completely immerse endoscopes and accessories in a non-corrosive, non-fixing disinfection bath that is changed daily.
- ❖ Leave endoscopes and accessories in disinfection bath for a maximum of 8 hours.
- ❖ Before machine cleaning and disinfection, rinse endoscopes and accessories thoroughly under clear running water.

#### 8.1.2 Dry Disposal

- ❖ Machine-clean endoscopes and accessories.

For the disposal, mind the following:

- ❖ Dispose of the packaging and used parts in accordance with the country-specific regulations.
- ❖ Protect the device from access by unauthorized persons.

## 9 Product Life cycle

Life cycle of medical device: 2 years or 400 cycles

After end-of-life cycle:

- ❖ Check Laparoscopes for: cleanliness, proper functioning, and damage, e.g., insulation, loose, bent, broken, cracked, worn, missing parts etc.
- ❖ If necessary, have Laparoscopes treated by Quest Medical Imaging B.V.
- ❖ If necessary, dispose of Laparoscopes correctly (see chapter 8)

## 10 Technical Specifications

Table 5: Technical specifications

Quest Spectrum® Laparoscope			
Length	290mm working length / 385mm total length		
Length short	150mm working length / 245mm total length		
Ambient operating temperature	10 – 40 °C		
Ambient operating humidity	20%-70%		
Laparoscope 30 degrees	30° / 70° (DOV/FOV)		
Laparoscope 0 degrees	0° / 70° (DOV/FOV)		
Length	290mm working length / 385mm total length		
Length short	150mm working length / 245mm total length		
Diameter	10mm		
Working distance	10mm – 150mm		
Life Cycle	2 years or 400 cycles		
Attributes / Accessories	Not applicable		
Autoclavable	Parameters	134 °C / 273°F Double fore-vacuum	132 °C / 270°F Double fore-vacuum
	Sterilization time	3 – 20 min	4 – 20 min
	Packaging	Metal sterilization containers, paper laminate sterilization bags, Type Striking	Metal sterilization containers, paper laminate sterilization bags, Type Striking
Dimensions	Article code	Identifier	Weight
	ART-LAP-0008	0 degrees	385 x 35 x 45 mm
	ART-LAP-0008S	30 degrees short	290 x 35 x 45 mm
	ART-LAP-0009	0 degrees	385 x 35 x 45 mm
	ART-LAP-0009S	0 degrees short	290 x 35 x 45 mm
Weight	Article code	Identifier	Weight
	ART-LAP-0008	30 degrees	180.8 g
	ART-LAP-0008S	30 degrees short	149.9 g
	ART-LAP-0009	0 degrees	181.4 g
	ART-LAP-0009S	0 degrees short	150.8 g

## 11 Manufacturer declaration

### Declarations of Conformity

Manufacturer: Quest Medical Imaging B.V.  
Industrieweg 41  
1775 PW Middenmeer  
the Netherlands

**We declare** under our sole responsibility that the Quest Spectrum® Laparoscope complies with the following directive:

Directive 93/42/EEC-M5 for medical devices



The individual components of your Quest Spectrum® Laparoscope bear the CE mark. Quest Medical Imaging B.V. herewith declares that:

- (a) We have verified the mutual compatibility of the devices of the Quest Spectrum® Laparoscope in accordance with the manufacturers' instructions and have carried out his operations in accordance with these instructions;
- (b) We have packaged the Quest Spectrum® Laparoscope and supplied relevant information to users incorporating relevant instructions from the manufacturers; and
- (c) We have subjected the whole activity to appropriate methods of internal control and inspection.